

**FRONT**

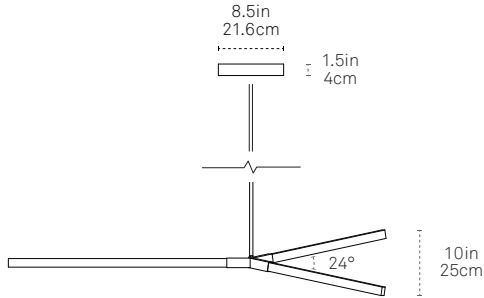

**SIDE**

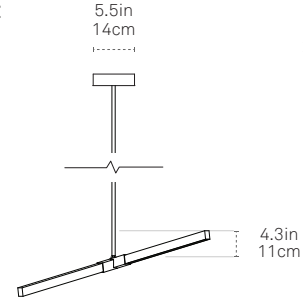

□ Bulb Profile  
0.81 in x 1.31 in  
2.1 cm x 3.3 cm

**PLAN**

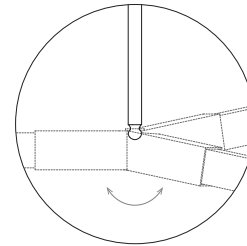
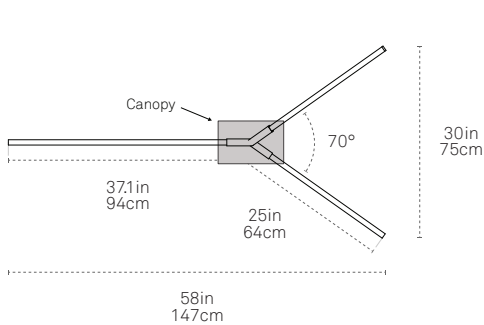

All Bough fixtures feature a 0-15° adjustable ball swivel that allows fixtures to be configured in different angles.

**SPECIFY PRODUCT OPTIONS:**

**MODEL**



WOOD	METAL	COLOR TEMP	DRIVER	OUTPUT	STEM	CEILING
<input type="checkbox"/>	<input type="checkbox"/>	<input type="checkbox"/>	<input type="checkbox"/>	<input type="checkbox"/>	<input type="checkbox"/>	<input type="checkbox"/>

**DESIGN**

© 2018

**PATENTS**

U.S. Patent #D860510

**MATERIALS**

LED, Sustainably Sourced or Reclaimed Wood, Steel

**FEATURES**

Fully Dimmable  
60-inch drop stem included  
15-degree adjustable ball swivel

**CERTIFICATIONS**



**ORIGIN OF MANUFACTURE**

New York City, USA

**FIXTURE WEIGHT**

13 lbs / 5.9 kg

**SHIPPING DIMENSIONS**

Ships flat-packed in a box  
62 in x 7 in x 11 in  
14 lbs / 6.4 kg

**LIGHT SPECIFICATION**

Standard Brightness LEDs :  
443 Lumens / 94 CRI (3000K) /  
14W Power draw

High Brightness LEDs :

812 Lumens / 90 CRI (3000K) /  
28W Power draw

**WOOD\***

Maple	<input type="checkbox"/>
American Walnut	<input type="checkbox"/>
Ebonized Oak	<input type="checkbox"/>
Heart Pine (Reclaimed)**	<input type="checkbox"/>
Water Tower Redwood (Reclaimed)**	<input type="checkbox"/>

\* Custom options available upon approval.

\*\* Our reclaimed woods exhibit variations in tone and grain.

**METAL\***

**STANDARD FINISH**

White	<input type="checkbox"/>
Slate Grey	<input type="checkbox"/>
Matte Black	<input type="checkbox"/>

**PREMIUM I FINISH**

Blackened	<input type="checkbox"/>
Brushed Nickel	<input type="checkbox"/>
Brushed Brass	<input type="checkbox"/>

**PREMIUM II FINISH**

Polished Nickel	<input type="checkbox"/>
Polished Brass	<input type="checkbox"/>

\* Custom options available upon approval.

**COLOR TEMP**

2400K	<input type="checkbox"/>
2700K	<input type="checkbox"/>
3000K (Standard)	<input type="checkbox"/>
4000K	<input type="checkbox"/>

**DRIVER & DIMMING OPTIONS**

120V (Phase dimming 2-wire)	<input type="checkbox"/>
120V-277V (Lutron Ecosystem 3-wire+G 1% dim.)	<input type="checkbox"/>
120V-277V (Universal dimming including 0-10V)**	<input type="checkbox"/>

\*\* Recommended for European orders

**LIGHT OUTPUT**

Standard Brightness - 12V (Dimmable)	<input type="checkbox"/>
High Brightness - 24V (Dimmable)	<input type="checkbox"/>

**STEM LENGTH\***

60" length of 3/8" rigid steel stem	<input type="checkbox"/>
120" length of 3/8" rigid steel stem	<input type="checkbox"/>
180" length of 3/8" rigid steel stem	<input type="checkbox"/>

\* Drop stem can be cut to length on site. 60" is included; contact a sales representative for 120" and 180" pricing.

**CEILING**

Flat Ceiling	<input type="checkbox"/>
Sloped Ceiling**	<input type="checkbox"/>

\*\* Canopy Dimension : 12"(L) x 5.5"(W) x 1.5"(H)



**1 2 0**

### 120V driver (2-wire+G Forward phase 1% dimming)

Full manufacturer’s specification sheets can be found at [stickbulb.com/drivers/120](http://stickbulb.com/drivers/120)

### Compatible Controls: Lutron Neutral-wire Dimmers

For assistance selecting controls contact Lutron at 1.877.346.5338 or LEDs@lutron.com

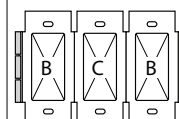
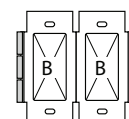
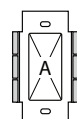

Product	Part Number	Low-End Setting/Load-Type Setting <sup>1</sup>	Drivers per Control		
			A: Not Ganged	B: End of Gang	C: Middle of Gang
RadioRA 2 adaptive dimmer	RRD-6NA-	Hi-lume 1% 2-Wire LTE LED <sup>2</sup>	1-10, 400 W max	1-10, 400 W max	1-10, 400 W max
RA2 Select/RadioRA 2 600 W dimmer	RRD-6ND	Hi-lume 1% 2-Wire LTE LED <sup>2</sup>	1-8, 350 W max	1-8, 350 W max	1-8, 350 W max
RadioRA 2 1000 W dimmer	RRD-10ND-	Set Device type to "INC/MLV Neutral Dimmer"; Set High-End Trim to 99%; Set Low-End Trim to 35%	1-13	1-13	1-13
RadioRA 2 Architectural RF GRAFIK T phase selectable dimmer	RRT-G5NEW-	Trim low-end per APM App Note (Lutron P/N 048534)	1-10, 400 W max	1-10, 400 W max	1-10, 400 W max
RadioRA 2 Architectural RF GRAFIK T dimmer	RRT-G25LW-	Trim low-end per APM App Note (Lutron P/N 048534)	1-10, 400 W max	1-10, 400 W max	1-10, 400 W max
RadioRA 2 C•L hybrid seeTouch keypad	RRD-HN	Hi-lume 1% 2-Wire LTE LED <sup>2</sup>	1-10, 200 W max	1-10, 200 W max	1-10, 200 W max
RadioRA 2 GRAFIK T C•L hybrid keypad	RRT-GH	Hi-lume 1% 2-Wire LTE LED <sup>2</sup>	1-10, 400 W max	1-10, 400 W max	1-10, 400 W max
HomeWorks QS adaptive dimmer	HQRD-6NA-	Hi-lume 1% 2-Wire LTE LED <sup>2</sup>	1-10, 400 W max	1-10, 400 W max	1-10, 400 W max
HomeWorks QS 600 W dimmer	HQRD-6ND-	Hi-lume 1% 2-Wire LTE LED <sup>2</sup>	1-8, 350 W max	1-8, 350 W max	1-8, 350 W max
HomeWorks QS 1000 W dimmer	HQRD-10ND-	Hi-lume 1% 2-Wire LTE LED <sup>2</sup>	1-13	1-13	1-13
Maestro Wireless 600 W dimmer	MRF2-6ND-120-	Trim low-end per APM App Note (Lutron P/N 048370)	1-8, 350 W max	1-8, 350 W max	1-8, 350 W max
Vive Maestro Wireless 600 W dimmer	MRF2S-6ND-120-	Trim low-end per APM App Note (Lutron P/N 048370)	1-8, 350 W max	1-8, 350 W max	1-8, 350 W max
HomeWorks QS GRAFIK T hybrid keypad	HQRT-GH	Hi-lume 1% 2-Wire LTE LED <sup>2</sup>	1-10, 400 W max	1-10, 400 W max	1-10, 400 W max
HomeWorks QS Architectural GRAFIK T dimmer	HQRT-G25LW-	Hi-lume 1% 2-Wire LTE LED <sup>2</sup>	1-10, 400 W max	1-10, 400 W max	1-10, 400 W max
HomeWorks QS Architectural GRAFIK T phase selectable dimmer	HQRT-G5NEW-	Hi-lume 1% 2-Wire LTE LED <sup>2</sup>	1-10, 400 W max	1-10, 400 W max	1-10, 400 W max
HomeWorks QS designer C•L hybrid seeTouch keypad	HQRD-HN	Hi-lume 1% 2-Wire LTE LED <sup>2</sup>	1-10, 200 W max	1-10, 200 W max	1-10, 200 W max
GRAFIK T C•L 250 W dimmer	GT-250M-, GTJ-250M-	Set low-end trim per dimmer installation instructions	1-10, 400 W max	1-10, 400 W max	1-10, 400 W max
Caséta Wireless Pro 1000 W dimmer	PD-10NXD-	Trim low-end per instructions at <a href="http://casetawireless.com/lowend">casetawireless.com/lowend</a>	1-13	1-13	1-13
Caséta Wireless phase selectable dimmer	PD-5NE-	Trim low-end per instructions at <a href="http://casetawireless.com/lowend">casetawireless.com/lowend</a>	1-20, 400 W max	1-20, 400 W max	1-20, 400 W max

<sup>1</sup> Setting the low-end trim and load type is necessary to ensure optimal performance and 1% dimming capability.

<sup>2</sup> Also listed as "LED Lutron A-Series 2-Wire" or "Hi-Lume A-Series LTE LED Driver 2-Wire" in previous software releases.

**(TO BE CONTINUED ON NEXT PAGE)**



(CONTINUED from 1 2 0 )

**Compatible Controls: Lutron Non-Neutral Dimmers**

For assistance selecting controls contact Lutron at 1.877.346.5338 or LEDs@lutron.com

Product	Part Number	Divers per Control	Low-End Setting/Load-Type Setting <sup>1</sup>		
Ariadni C•L 250 W dimmer	AYCL-253P-	Set low-end trim dial to 1 o'clock. Adjust slightly if needed.	1-8, 350 W max	1-8, 350 W max	1-8, 350 W max
Ariadni C•L 150 W dimmer	TGCL-153P-, AYCL-153P-	Set low-end trim dial to 1 o'clock. Adjust slightly if needed.	1-6, 250 W max	1-6, 250 W max	1-6, 250 W max
Diva C•L 250 W dimmer	DVCL-253P-, DVSCCL-253P-	Set low-end trim dial to 10 o'clock. Adjust slightly if needed.	1-8, 350 W max	1-8, 350 W max	1-8, 350 W max
Diva C•L 150 W dimmer	DVCL-153P-, DVSCCL-153P-	Set low-end trim dial to 10 o'clock. Adjust slightly if needed.	1-6, 250 W max	1-6, 250 W max	1-6, 250 W max
Nova  C•L 250 W dimmer	NTCL-250-	Set low-end trim dial to 10 o'clock. Adjust slightly if needed.	1-10, 400 W max	1-10, 400 W max	1-10, 400 W max
Lumea C•L 150 W dimmer	LECL-153P-	Set low-end trim dial to 10 o'clock. Adjust slightly if needed.	1-6, 250 W max	1-6, 250 W max	1-6, 250 W max
Sylark C•L 150 W dimmer	SCL-153P-	Set low-end trim dial to 10 o'clock. Adjust slightly if needed.	1-6, 250 W max	1-6, 250 W max	1-6, 250 W max
Contour C•L 150 W dimmer	CTCL-153P-	Set low-end trim dial to 10 o'clock. Adjust slightly if needed.	1-6, 250 W max	1-6, 250 W max	1-6, 250 W max
myRoom DIN power module	MQSE-4A1-D	1-6 (per output); 1 A maximum driver input current	Hi-lume 1% 2-Wire LTE LED <sup>2</sup>		
HomeWorks QS DIN power module	LQSE-4A1-D	1-6 (per output); 1 A maximum driver input current	Hi-lume 1% 2-Wire LTE LED <sup>2</sup>		
HomeWorks QS Phase Adaptive DIN power module	LQSE-4A-120-D	1-6 (per output); 2 A maximum driver input current	Hi-lume 1% 2-Wire LTE LED <sup>2</sup>		
HomeWorks QS wallbox power module	HQRJ-WPM-6D-120	2-10 (per output); 26 total per module	Hi-lume 1% 2-Wire LTE LED <sup>2</sup>		
HomeWorks wallbox power module	HWI-WPM-6D-120	2-10 (per output); 26 total per module	Set load type to "GRX-FDBI or GRX-TVI"		
GRAFIK Eye QS control unit	QSGR-, QSGRJ-	2-10 (per output); 26 total per unit	Set load type to "Fluorescent Module"		
GRAFIK Eye 3000 control unit	GRX-3100-, GRX-3500-	2-10 (per output); 26 total per module	Set load type to "GRX-FDBI" or "GRX-TVI"		
RPM-4U module (LCP, HomeWorks QS, GRAFIK Systems, Quantum)	HW-RPM-4U-120, LP-RPM-4U-120	2-26 (per output); 26 total per module	Hi-lume 1% 2-Wire LTE LED <sup>2</sup> Set load type to "2-1"		
RPM-4A module (LCP, HomeWorks QS, GRAFIK Systems, Quantum)	HW-RPM-4A-120, LP-RPM-4A-120	1-13 (per output); 26 total per module	Hi-lume 1% 2-Wire LTE LED <sup>2</sup> Set load type to "2-1"		
GP dimming panels	Various	1-26	Set load type to "2-1"		

<sup>1</sup> Setting the low-end trim and load type is necessary to ensure optimal performance and 1% dimming capability.

<sup>2</sup> Also listed as "LED Lutron A-Series 2-Wire" or "Hi-Lume A-Series LTE LED Driver 2-Wire" in previous software releases.



# DIMMING COMPATIBILITY

## Lutron Hi-Lume 1% EcoSystem/3-Wire L3D

Featuring SoftOn/FadeToBlack  
Standard & High Brightness

2	7	7
---	---	---

### 120-277V driver (3-wire+G 1% dimming)

Full manufacturer's specification sheets can be found at [stickbulb.com/drivers/277](http://stickbulb.com/drivers/277)

### Compatible Controls

For assistance selecting controls, contact Lutron at 1.877.346.5338 or LEDs@lutron.com

Product	Part Number		Drivers per Control				Measured Light Output Range
			40 W Driver		50 W Driver		
	120 V ~	277 V ~	120 V ~	277 V ~	120 V ~	277 V ~	
<b>3-wire Controls:</b>							
Nova T	NTF-10-	NTF-10-277-	1-41	1-44	1-31	1-36	100%-1%
	NTF-103P-	NTF-103P-277-	1-20	1-33	1-15	1-27	100%-1%
Nova	NF-10-	NF-10-277-	1-41	1-44	1-31	1-36	100%-1%
	NF-103P-	NF-103P-277-	1-20	1-33	1-15	1-27	100%-1%
Skylark	SF-10P-	SF-12P-277-	1-20	1-33	1-15	1-27	100%-1%
	SF-103P-	SF-12P-277-3	1-20	1-33	1-15	1-27	100%-1%
Diva	DVF-103P-	DVF-103P-277-	1-20	1-33	1-15	1-27	100%-1%
	DVSCF-103P-	DVSCF-103P-277-	1-20	1-33	1-15	1-27	100%-1%
Ariadni	AYF-103P-	AYF-103P-277-	1-20	1-44	1-15	1-27	100%-1%
Maestro	MAF-6AM-	MAF-6AM-277-	1-15	1-20	1-11	1-20	100%-1%
	MSCF-6AM-	MSCF-6AM-277-	1-15	1-20	1-11	1-20	100%-1%
Maestro Wireless	MRF2-F6AN-DV-		1-15	1-33	1-11	1-27	100%-1%
RadioRA 2	RRD-F6AN-DV-		1-15	1-33	1-11	1-27	100%-1%
HomeWorks QS	HQRD-F6AN-DV		1-15	1-33	1-11	1-27	100%-1%
Interfaces <sup>1</sup>	PHPM-3F-120	-	1-41	-	1-31	-	100%-1%
	PHPM-3F-DV		1-41	1-88	1-31	1-72	100%-1%
GP Dimming Panels	Various		1-41	1-88	1-31	1-72	100%-1%
<b>EcoSystem Controls:</b>							
PowPak dimming module with EcoSystem	RMJ-ECO32-DV-B		32 per EcoSystem link				100%-1%
	FCJ-ECO		3 per EcoSystem link <sup>2</sup>				100%-1%
Energi Savr Node with EcoSystem	QSN-1ECO-S, QSN-2ECO-S		64 per EcoSystem link				100%-1%
GRAFIK Eye QS with EcoSystem	QSGRJ-_E, QSGR-_E	-	64 per EcoSystem link				100%-1%
Quantum	Various		64 per EcoSystem link				100%-1%

<sup>1</sup> For use with 3-wire controls or Commercial Systems, RadioRA 2 Systems or Home Systems applications.

<sup>2</sup> Up to 3 drivers controlled as a single zone (broadcast EcoSystem).



**0 1 0**

### 120V-277V driver (Universal dimming including 0–10V)

Full manufacturer’s specification sheets can be found at [stickbulb.com/drivers/010](http://stickbulb.com/drivers/010)

### Low-Voltage Compatible Dimmer brands: Crestron, Lutron, Leviton

For assistance selecting controls, contact LTF at +1 (847) 498-5832 or [LTFsales@LTFtechnology.com](mailto:LTFsales@LTFtechnology.com)

Brand	Part number	Brand	Part number	Brand	Part number
Crestron	CLS-C6	Lutron	DVCL-153P	Leviton	Model 6615
Crestron	CLS-C6M	Lutron	DVELV-303P	Leviton	Model 6672
Crestron	CLS-C6EX	Lutron	HQRD-6A	Leviton	Model 6674
Crestron	CLS-C6MEX	Lutron	HQRD-6NA-	Leviton	Model IPL06
Crestron	CLS-EXP-DIM	Lutron	NTELV-300-	Leviton	Model IPE04
Crestron	CLS-EXP-DIMU	Lutron	NTELV-600-	Leviton	Model IPI06
Crestron	CLX-2DIM8	Lutron	NVELV-600-	Leviton	Model VP106
Crestron	DIN-1DIM4	Lutron	VTELV-600M	Leviton	Model VPE04
Crestron	DIN-1DIMU4	Lutron	MAELV-600-	Leviton	Model VPM06
Crestron	CLW-DIMEX-E	Lutron	MSCELV-600M	Leviton	Model VRE04
Crestron	CLW-DIMEX-P	Lutron	MIRELV-600-	Leviton	Model VRM10
Crestron	CLW-DIMSWEX-E	Lutron	MRF2-6ELV-120-		
Crestron	CLW-DIMSWEX-P	Lutron	SELV-300P		
Crestron	GLX-DIM6	Lutron	CTELV-303P		
Crestron	GLXX-2DIM8	Lutron	SELV-600-		
Crestron	P-DIMEX				
Crestron	CLW-DELVEX-E				
Crestron	CLW-DELVEX-P				



All of our wood and metal products should be dusted by hand with a dry Swiffer pad (or equivalent) on a regular schedule to maintain surface integrity. It is imperative that none of our products come into contact with bleach, vinegar, lemon juice or any household product which may contain these or other solvents.

If any part of one of our fixtures becomes soiled with dried residue or grime, wipe the affected area with a soft cloth dampened very lightly with warm water and immediately wipe dry with another soft cloth. If this does not complete the task, wipe with a cloth soaked in diluted mild liquid dish soap and again immediately dry.

Fingerprints on our Nickel-plated, Brass-plated, and Blackened metal hardware can be removed with a clean, dry, soft cloth. We recommend an ultra-fine, textureless microfiber cleaning cloth (as one uses to clean glass).

All of our Brass hardware is treated with a protective coating to prevent tarnish. It should need no more than a wipe with a clean, dry, soft cloth to remove fingerprints and dust.

Brushed metal surfaces should be buffed in the direction of the grain.

For scratches in wood we highly recommend Claphams beeswax, which is non-toxic and can be applied by hand. Rub a small amount into the scratch area and buff with a dry cloth.

